

LAUNCH
TECH USA
FOCUS & INNOVATE

**PRODUCT
CATALOG**

2026 **ISSUE 1**

Smart



PROFESSIONAL TOOLS 04



HD SOLUTION 12



DIY PRODUCTS 31



INSPECTION 36



X-431 MODULES 54

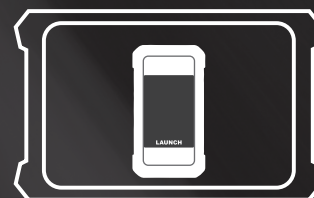

SMARTLINK TOOLS 59



EV TOOLS 18



TPMS
PRODUCTS 28



SHOP
EQUIPMENT 41



IMMO
PRODUCTS 50

CONTENTS

WHICH BI-DIRECTIONAL SCANNER IS RIGHT FOR YOU?



X-431 THROTTLE V



X-431 TORQUE LINK

X-431 TURBO III

FULL SYSTEM | OE-LEVEL COVERAGE | TECH 2 TECH
SMARTLINK REMOTE DIAGNOSIS
SECURITY GATEWAY ACCESS | CODE ASSIST



X-431 Throttle V



X-431 Torque LINK



X-431 Turbo III

CONFIGURATION

Touch Screen	13.6"/2560*1600	10.1"/1280*800	8"/1280*800
Processor	2.0GHz Octa-core	2.0 GHz 4-core	2.0 GHz 4-core
Memory	12GB	4GB	4GB
Storage	512GB	128GB	64GB
Camera	Front 8MP, Rear 20MP	Front 5MP, Rear 8MP	Front 5MP, Rear 8MP
Battery	71.1Wh (7.6V, 9360mAh)	47.88Wh (7.6 V, 6300mAh)	47.88Wh (7.6 V, 6300mAh)
VCI Connection	2.4GHz & 5GHz dual Wi-Fi	Bluetooth	Bluetooth
VCI Adaptor	Smartlink C	Smartlink C	DBSCARVII
Adjustable Kickstand	•	•	•
IP65 Waterproof & Dustproof	•		

FEATURES

Vehicle Coverage	1996-Present Passenger cars Medium & Light Duty Vehicles/ Heavy Duty Vehicles (Optional)	1996-Present Passenger cars Medium & Light Duty Vehicles/ Heavy Duty Vehicles (Optional)	1996-Present Passenger cars Medium & Light Duty Vehicles
Operating System	Android™ 13.0	Android™ 10.0	Android™ 10.0
Full System Diagnosis	•	•	•
OBD II Full Function	•	•	•
Tech 2 Tech Remote Diagnosis	•	•	•
Smartlink Remote Diagnosis	•	•	
Auto Vin Identification	•	•	•
Wi-Fi Updatable	•	•	•
Security Gateway Access	•	•	•
Code Assist by IDENTIFIX	•	•	•
X-431 FIX by Motor	• (included)	•	•
VW & AUDI Guided Function	•	•	•
CAN FD	•	•	•
DolP	•	•	• *(Adaptor needed 105022532)

COMPATIBLE MODULES

X-431 ADAS PRO Plus	•	•	•
X-431 ADAS Mobile Plus	•	•	•
X-431 ADAS HD	•	•	
X-PROG 3 Immobilizer	•	•	•
BST360 Battery Tester	•	•	•
VSP600 Videoscope	•	•	•
VSP-828 Videoscope	•	•	•
Tread Master	•	•	•
HD Add-on Module	•	•	
O2-2 4 Channel Scopebox	•	•	
S2-2 Sensorbox	•	•	

X-431 THROTTLE V

P/N: 341184002



FEATURES

- 13.6-inch 2K high-definition display with a new dual-color design.
- Equipped with 12GB RAM + 512GB ROM and a long-lasting battery for faster, more reliable performance.
- Features topological graph multisystem module fast scanning for quick diagnostics.
- Smart diagnosis using VIN auto-identification, allowing quick entry into the diagnostic process.

- One-click Wi-Fi update for software.
- Supports a range of optional extension modules, including TPMS tools, ADAS calibration equipments, videoscope, battery tester, and X PROG-3 IMMO programmer.
- Enables remote diagnosis, allowing technicians to assist remotely.
- Offers Code Asisst by *IDENTIFIX* and X-431 FIX services by *MOTORDRIVEN*, providing millions of DTC solutions in no time.

SPECIFICATIONS // (X-431 THROTTLE V)



Android™ 13.0



2.0GHz Octa-core



13.6" touch screen



512GB Storage



Front 8MP, Rear 20MP



32°F~122°F



12GB RAM



14.83x9.69x1.38(in)

SPECIFICATIONS // (SMARTLINK)



3.5" touch screen



8GB RAM



32°F~122°F



8.03x4.33x1.77 (in)

X-431 TORQUE LINK

P/N: 321195101



FEATURES

- U.S. vehicle coverage in addition to Asian, European coverage from 1996 and newer.
- Vehicle health report feature gives comprehensive status on all onboard systems of vehicle.
- Supports Communication protocols CAN/CANFD/DoIP and automotive communication standards J2534/D-PDU/RP1210.
- Topology module mapping provides a virtual overview of all on board control modules and their communication statuses.

- TECH 2 TECH remote diagnostics and technician collaboration.
- Monitor the vehicle's voltage in real time during live diagnostics.
- Code Assist by **IDENTIFIX**, access most common fixes and repair solutions with corresponding DTC'S.
- Supports X-431 Fix repair information, driven by **MOTOR DRIVEN**
- Auto-detect VIN to access vehicle info within seconds.
- Supports optional extension modules, ADAS calibration, ADAS HD, Immobilizer, Battery Tester, Videoscope, Oscilloscope and Sensorbox.
- Approved Security Gateway access.
- Bi-directional functionality.
- Supports Smartlink Remote Diagnosis.

SPECIFICATIONS



Smartlink



1280*800



128GB Storage



4GB RAM



47.88Wh
(7.6V, 6300mAh)



Android™ 10.0



Rear 8MP, Front 5MP



10.1"



2.0GHz 4-core

X-431 TURBO III

P/N: 321195201



FEATURES

- U.S. vehicle coverage in addition to Asian, European coverage from 1996 and newer.
- Vehicle health report feature gives comprehensive status on all onboard systems of vehicle.
- TECH 2 TECH remote diagnostics and technician collaboration.
- Code Assist by **IDENTIFIX**, access most common fixes and repair solutions with corresponding DTC'S.
- Guided function for VW & AUDI.
- Bi-directional functionality.
- Approved Security Gateway access .
- Auto-detect VIN to access vehicle info within seconds.
- Monitor the vehicle's voltage in real time during live diagnostics.
- Supports optional extension modules, ADAS calibration, ADAS HD, Immobilizer, Battery Tester, Videoscope, and Oscilloscope.
- Supports X-431 Fix repair information, driven by **MOTOR DRIVEN**

SPECIFICATIONS



DBSCARVII



1280*800



64GB Storage



4GB RAM



47.88Wh
(7.6V, 6300mAh)



Android™ 10.0



Rear 8MP, Front 5MP



8"



2.0GHz 4-core

X-431 FIX AUTO

P/N: 108040328



All Launch X-431 professional level scan tools can now incorporate X-431 FIX by Motor. This repair and diagnostic reference database is designed to assist technicians during diagnostics by providing information on TSBs (Technical Service Bulletins), flow charts, repair procedures, wiring diagrams, and other manufacturer documents.

SUPPORTED PRODUCTS



X-431 THROTTLE V
(Standard with Subscription)



X-431 TORQUE LINK



X-431 TORQUE AUTOHD PRO



X-431 TURBO III

HEAVY-DUTY COVERAGE

SECOND TO NONE IN THE AFTERMARKET



X-431
Torque AutoHD Pro

X-431
Millennium HD ProA



X-431
HD Add On Module



X-431
Fix HD

PROFESSIONAL LEVEL FUNCTIONALITY
COMPLETE VEHICLE COVERAGE

MILLENNIUM HD ProA

P/N: 301050830



FEATURES

- 8 special functions including DPF regeneration, DEF Pump Actuation, maintenance light reset, fuel injector coding, and clutch learning, etc.
- Supports functions such as viewing diagnostic reports, replaying diagnostic records, taking screenshots and sharing.
- Equipped with code reading, code clearing, and data stream reading functions.
- Auto VIN detect function identifying vehicle information.
- One-click Software updates via Wi-Fi.

8 SERVICE FUNCTIONS



DFP Regen



DEF Pump Actuation



Injector Coding



Brake Reset



Cylinder Cutout Testing



Clutch Learning



Maintenance Light Reset



Speed Limit

SPECIFICATIONS



Standards OBD II Type-C



3.97"



Android™ 8.1



2+16GB



3000mAh



WIFI 2.4GHz (b/g/n)



-14°F~122°F



-4°F~158°F

X-431 TORQUE AUTOHD PRO

P/N: 301190908

**TORQUE LINK, PLUS ALL THE POWER FOR
COMMERCIAL VEHICLE DIAGNOSTICS.**



13 SERVICE FUNCTIONS // (HEAVY-DUTY ONLY)

- DPF Regeneration
- Injector Coding
- Reset Service (MIL)
- Maintenance Confirmation
- Parked SCR Efficiency
- Bleeding The Adblue Circuit
- Trip Reset
- VGT Electronic Actuator Installation and Calibration
- Injection Quantity Adjustment
- Particulate Filter Replacement Reset
- Reset Pressure Diffieerential Sensor
- Reset Pressure Limiting Valve
- DPF Ash Accumulator Reset

CALIBRATION // (HEAVY-DUTY ONLY)

- Idle Speed Adjustment
- Speed Limit
- Cruise Control
- Idle Timer
- PTO
- Coolant Level Switch
- Exhaust Brake Valve
- Intake Air Preheating
- Vehicle Speed Controller
- Air Conditioner
- Oil Pressure Sensor
- Electronic Fan
- ABS
- Automatic Transmission

A COMPREHENSIVE AUTOMOTIVE AND HEAVY-DUTY DIAGNOSTIC TOOL

The X-431 Torque AUTOHD PRO serves as a diagnostic solution catering to both Automotive and Commercial Heavy Duty Truck Diagnostics.







FEATURES

- Works on various systems, including Engine, Transmissions, ABS, and Auxiliary from manufacturers such as Wabco, Bendex, and Allison.
- Monitor the vehicle's voltage in real time during live diagnostics.
- U.S. vehicle coverage in addition to Asian, European coverage from 1996 and newer.
- Integrated with new the powerful hardware X-431 Torque AutoHD Pro tablet, and Smartlink VCI, maximizethe ability to faster diagnosis.
- Supports Cummins, Detroit, Freightliner, Fuso, Hino, International, Isuzu, KW, Peterbilt, Sterling, and Volvo.
- Guided VW & AUDI functions
- Code Assist by *IDENTIFIX*, access most common fixes and repair solutions with corresponding DTC'S.
- Approved Security Gateway access.
- Read and erase DTCs of light, medium and heavy-duty vehicles [Class 4 through 8].
- Optional ADAS calibration application to calibrate LDW, RCW, AVM, NV, BSD and ACC system accurately.
- Wireless and wired communicates via Bluetooth and USB.
- Multilingual menu and data display: English, Spanish, and French.

SPECIFICATIONS (TORQUE AUTOHD PRO)

 Smartlink	 1280*800	 128GB Storage	 4GB RAM
 47.88Wh (7.6V, 6300mAh)	 Android™ 10.0	 Rear 8MP Front 5MP	 10.1"
 2.0GHz 4-core			

SPECIFICATIONS (SMARTLINK C HEAVY-DUTY MODULE)

 3.95", 320*480	 2.4GHz/5GHz	 8GB Storage	 256MB RAM
 7.88*4.33*1.85	 9V DC-36V DC	 Wi-Fi Bluetooth & Ethernet	

X- HD ADD ON

P/N: 301181163



VEHICLE COVERAGE

Mack, Hino, UD Truck/Nissan Diesel, Cummins, Ferrara, Dina, Forest River, Kohler, Versatile, Jayco, Allison transmission, Isuzu, Fuso, Kalmar Ottawa, Eldorado, Gillig, Challenger, Weycor, Tiffin, Bendix ABS, Standard, Paccar, KME, NABI, Holiday Rambler, Ditch Witch, Newell, Komatsu, Detroit, Autocar, AutoSearch, Oshkosh, New Flyer, IC Bus, Peterbilt, Diesel Mitsubishi, Thomas Built, Spartan, Orion, Allegro, Gradall, Damon, Freightliner, Diesel Nissan, Blue Bird, Winnebago, Prevost, Volvo Engineering Machinery, Hagie, Scarab, Kenworth, Diesel Toyota, John Deere, Monaco, Ranegade, HD Flexicoil, Leeboy, Sterling, MaxxForce, Scania, American Coach, Starcraft, Miller, MacDon, LoneStar, Haldex ABS, Deutz, Battisti, Startrans, PSI, McCormick, Irizar, Western Star, GM diesel, Case, BCI, Temsa, Volvo marine, Skyjack, Newmar, Eaton, USAFORD diesel, New Holland, Berkshire, Van Hool, Mercedes-Benz, Sprinter diesel, AL-KO, Champion, Elkhart, DAF, Stara, Nexus RV, Volvo, Chrysler diesel, American Lafrance, Claval, ENC, ASV, Terex, Entegra Coach, Thor Motor Coach, E-One, Fleetwood, Wittmann, Crusader Marine, Branson, and Caterpillar.

AVAILABLE ON



X-431 THROTTLE V



X-431 TORQUE LINK

X-431 FIX HD

P/N: 107990031



The Truck Service module provides service and repair information for the vehicle industry, excluding International. It encompasses various segments such as Commercial Light Truck & Van, Medium & Commercial Vehicle, Engine, Trailer, and Various Major Components.

SUPPORTED PRODUCTS



X-431 THROTTLE V



X-431 TORQUE LINK



X-431 Torque Auto HD Pro

NEW ENERGY VEHICLE SOLUTION

MAINTENANCE AND DETECTION



EVT511



EVB624



EVP711



ELA400



DIAGNOSTIC ADD-ON KIT



TLT615A



TTH 116 EV Tool Cart



ES200



EG100 EV CLAMP

EV & BATTERY PACK

DIAGNOSTIC ADD-ON KIT

P/N: 301181133

LAUNCH New Energy Battery Pack Diagnostic Upgrade Kit comes with battery pack testing cables for various vehicle brands. The battery pack diagnostic software and some diagnostic software for new energy vehicles can be activated and downloaded with the included activation card.



FEATURES

- Quick reading for battery pack information, such as the number of battery pack modules, SOC, SOH, temperature, single cell's, voltage and temperature of each module, etc., which will help technicians knowabout the battery status.
- Battery pack data stemming helps to locate issues accurately and improve repairing efficiency.
- Supports various battery pack diagnostic methods including non-standard battery pack connector, jumper cables and 16 PIN OBD.
- Battery pack diagnostic report can be printed and shared via email.

NEW ENERGY VEHICLES COVERAGE

VW, BMW, MERCEDES, AUDI, TESLA, TOYOTA, HONDA, FORD, LEXUS, MAZDA, KIA, LAND ROVER, JAGUAR, INFINITI, VOLVO, PORSCHE, etc.

BATTERY PACK COVERAGE

PANASONIC, SAMSUNG SDI, SK INNOVATION, CATL (Contemporary Amperex Technology), etc.

EVB624

MODULARIZED WIRELESS EQUALIZER

P/N: 307070101







FEATURES





- Separate charge/discharge design with flexible equalization channels combination for up to 24 cells.
- Wireless networking for easy extension of channel numbers.
- Compatible with most common Li-ion battery types.
- Isolated, high-precision voltage acquisition for secure and accurate equalizing control.
- Supports both charge and discharge equalizing modes.
- Independent cell wiring to prevent connection errors.

FUNCTIONS

- **Equalizing Maintenance**
Supports discharge and charge-discharge equalizing modes, capable of maintaining batteries such as NMC, LiFePO4 and LMO batteries.
- **Data Analysis**
Automatically saves historical equalization records and supports display in curve and bar chart formats.
- **Multiple Protections**
Provides safety protections against overvoltage, undervoltage, overcurrent, output short circuit, reverse polarity, and overtemperature.
- **Data Transfer**
Allows for export of historical data to a USB flash drive in Excel file format.

SPECIFICATIONS

 Power Input AC90~264V, 50Hz/60Hz	 Display 10.1" LCD touch screen
 Output Voltage Range DC 0~112V	 Dimension 381*270*275 (mm) 15.0*10.63*10.83 (in)
 Output Current Range 1~40A	Charge unit

 Number of Channels 4 channels	 Communication Method Wi-Fi, BT
 Discharge Voltage Range DC2.8~4.2V	 Dimension 215*100*130 (mm) 8.46*3.94*5.12 (in)
 Discharge Current Range 1~10A	Discharge unit

EVT511

EV BATTERY AIRTIGHTNESS TESTER

P/N: 307070100

FEATURES

- Allows presetting of battery pack parameters like volume, pressure, test time, and leakage limits.
- Pressure gauge equipped to display real-time pressure curve.
- High-sensitivity pressure sensing for accurate and stable result.

FUNCTIONS

● Low-Pressure Air Tightness Testing:

Utilizes compressed air as a medium to apply a certain pressure inside the battery pack cavity, and a high-sensitivity sensor is used to detect changes in pressure and determine its sealing.

● Parameter Settings:

Allows for the presetting of parameters such as workpiece number, volume, pressure, time for each stage, and leakage limit.



● Process Visualization:













Displays the work status of stages such as inflation, pressure stabilization, leakage, and exhaust in real-time.

● Real time display of leakage amount.

● Detection History:

Automatically saves history records and supports the display of detailed data via curve graphs.

SPECIFICATIONS

 WORKING POWER 20W (Max)	 TEST PRESSURE RANGE 0~30Kpa	 SENSOR RESOLUTION 1Pa	 TEST ACCURACY ±5pa
 COMMUNICATION INTERFACES RS-485/USB	 DATA STORAGE METHOD Internal storage upload to USB drive	 POWER SUPPLY AC90-264V, 50Hz/60Hz	 DISPLAY 10.1" LCD screen
 AIR SOURCE REQUIREMENTS 0.1~1.0 Mpa dry compressed air	 INTAKE PORT / TEST PORT φ6mm/φ6mm	 WORKING TEMPERATURE HUMIDITY 50~131°F / 10%~90% at 77°F	 DIMENSION&WEIGHT 349*329*366.5 (mm)/4.0kg 13.74*12.95*14.43 (in) / 8.82 lbs

EVP711

EV BATTERY PACK MODULE CHARGING & DISCHARGING EQUIPMENT

P/N: 307070102

FEATURES

- Support majority of lithium batteries and all nickel-hydrogen batteries.
- Minimized interferences to the BMS.
- Warns of alerts to ensure hardware safety.
- Wide voltage design with multiple charging/discharging modes.
- Flexible setting of charging and discharging rules.

FUNCTIONS

● Charging/Discharging Test

Wide voltage design suitable for battery module charging and discharging test across different voltage levels, supporting a variety of lithium batteries and nickel-metal hydride batteries.

● Voltage Collection of Individual Cells and Group Terminals

Enables real-time acquisition of group terminal voltages and individual cell voltages.

● Individual Cell Protection

Allows the setting of current and voltage protection thresholds for cells to prevent overcharging and overdischarging.

● Group Terminal Charge/Discharge Protection

Provides protection against overvoltage, undervoltage, overcurrent, output short-circuit, reverse connection, and overtemperature.

● Parameter Setting

Allows presetting of work modes, battery types, voltage thresholds, working current, and the number of cells.

● Data Visualization

Real-time monitoring of individual cell voltages, terminal currents and voltages, charge/discharge states, and capacities during the charge/discharge process.

● Data Storage

Automatically saves historical charge/discharge records and supports exporting historical data as Excel files to a USB flash drive.



SPECIFICATIONS



Power Input
AC90~264V, 50Hz/60Hz



Charging & Discharging Voltage Range
DC 2~400V



Charging current range
Maximum Current 100A
Maximum Power 4.4kW



Discharge current range
Maximum Current 100A
Maximum Power 7.2kW



Data communication
RS-485



Charging Control
Constant Current Charging
Constant Voltage Charging



Discharge Working Mode
Constant Current Discharge



DISPLAY
10.1" LCD screen

ELA400

INTELLIGENT DIGITAL POWER SUPPLY

P/N: 307060092





FEATURES

- The high-voltage and low-voltage modules can be managed, maintained and monitored separately, allowing individual protection for each module during power output without mutual interference.
- Built-in cooling fan with intelligent temperature control.
- Independent protection mechanisms are implemented in the input circuit, high-voltage output circuit, and low-voltage output circuit. These mechanisms can detect faults such as undervoltage, overvoltage, overcurrent, and short circuits etc. Fault protection alarms are supported.

SPECIFICATIONS

 **Power Input**
AC100~240V@20A

 **High-voltage voltage**
50~900V

 **High-voltage current**
0~5A

 **High Voltage**
Voltage Knob, Current Knob,
High Voltage switch button

 **Low-voltage voltage**
0~50V

 **Low-voltage current**
0~15A

TLT615A

EV BATTERY PACK LIFT

















P/N: 307070128



FEATURES

- Streamline battery pack replacements and maintenance tasks, improving overall productivity while ensuring technician safety.
- Features a dual scissor arm and dual cylinder lifting system with a maximum load capacity (theoretical limit the lift can support under perfect conditions) of 10,000 kg in a straight line.
- Floating movable platform: Composed of an upper floating platform and a lower angle adjustment frame.
- Equipped with 2 curved PU straight wheels and 2 curved PU universal wheels with brakes, offering flexible steering and easy mobility.
- Handheld box with magnetic button control for lifting and lowering, providing safe and easy operation.
- Strong power in various conditions is provided by an AC asynchronous motor (220V, 0.75KW, 13Mpa), and an aluminum alloy power unit with a CE-certified transformer included.
- Features a step-by-step limit rack design, coupled with an electromagnetic switch-driven locking tongue and equipped with a travel limit switch, significantly enhancing operational safety.
- A throttle valve is installed at the front end of the oil pipe components to maximize oil circuit safety.
- The tabletop is densely covered with tooling holes for selecting optional tabletop head components.

SPECIFICATIONS

 Rated Lifting Weight 3306.93 lb	 Lifting Height 74.41 in	 Platform Length 70.87 in	 Platform Width 31.50 in
 Size 100.39 x 38.19 x 43.31 in	 Platform Floating Distance 4 directions ± 1.18 in	 Platform Swing X-Axis Angle 4°	 Platform Swing Y-Axis Angle 4°
 Pallet Height 6.30 - 8.27 in	 Lifting Time 20-30s	 Lowering Time 10-120 s adjustable	 Working Voltage 110V/60HZ/Single Phase
 Power 10.75KW	 Package Size 92.52 x 40.55 x 33.46 in (wooden box)	 Net Weight 1102.31 lb	 Gross Weight 1212.54 lb

TTH 116 EV Tool Cart

P/N: 704020213



FEATURES

- The variety of insulation tools all complete, which can meet the needs of most new energy vehicle disassembly and maintenance operations on the market.
- All tools have obtained VDE, IEC60900, GS, and CE certifications.

TOOL SET REFERENCE

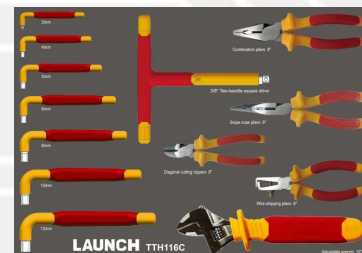
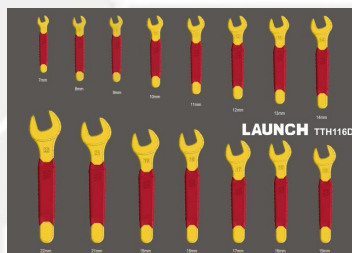
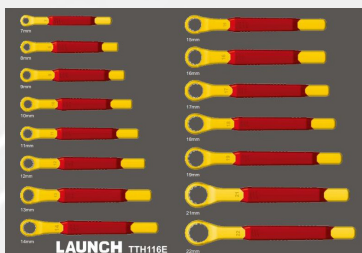

ES200

PROFESSIONAL INSULATION TESTER

P/N: 301181047



FEATURES

- ES200 is capable of measuring insulation resistance, and also innovatively increases the voltage measurement function.
- Three measurement modes: timing measurement, comparison measurement, continuous measurement, and omnidirectional measurement.
- Equipped with standard resistance, in comparison measurement mode, the measured resistance value is compared with the standard resistance to ensure the measurement accuracy.

SPECIFICATIONS



BATTERY
3150 mAh



DISPLAY
5"



WORKING TEMPERATURE
32~122°F



DIMENSIONSWidth
7.09*6.85*2.58 (in)



WEIGHT
3.75 lbs

EG100 EV CLAMP

P/N: 301180910



SIMPLE AND SAFE

Non-contact OC testing can detect when power is on.



FAST AND ACCURATE

Ultra-high sampling frequency combined with a noise reduction algorithm enables



COMPACT AND PORTABLE

Ergonomic design, portable, and easy to use.



DATA STABILITY

Immune to EMI and provides stable and reliable measurement data.



FEATURES

DC Current Testing

- Tailored for Electric Vehicles (EVs) with the capability for concurrent measurement of both current and voltage.
- Supports measurement range selection.
- Supports real-time test value digital display.
- Supports maximum, minimum, and peak-to-peak value display.
- Record and playback the measurement waveform.

AC Current Test

- Display AC Lower current data.
- Supports measurement range selection.
- Supports real-time test value digital display.
- Supports maximum, minimum, and peak-to-peak value display.
- Record and playback the measurement waveform.

SPECIFICATIONS



Test Mode

Clamp CT non-contact measurement



Battery

9V dry battery



Phase Error

3° (AC 50Hz/60Hz)
73.4°F ± 3.6°F



Frequency Response

DC-50kHz



Accuracy

±3%FS
(73.4°F ± 9°F, < 75%rh)



Jaw Size

cp16mm x 18mm
(outer diameter of clampable wire)



Input Measuring Range

0-200AAC/DC



Resolution

1mA AC/DC



Output Gear

10mV/A (0-20 A)
100 mV/A(0-200 A)



Working Current

500mA



Working Temperature

32-122°F



Dimension

10.95*2.8*1.46 (in)



The ZERO button can be used for zero adjustment to eliminate the interference of geomagnetic field and external electric field

ALL-NEW TPMS SOLUTIONS

*ACTIVATE, READ, RELEARN & PROGRAMMING
STAND-ALONE | TPMS TECH | DIAGNOSE WITH ACCURACY*



TSAP-5



TSAP-3



Launch Sensor

TSAP-5 P/N: 302020533

Wi-Fi UPDATABLE & TOUCHSCREEN

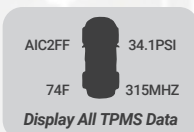
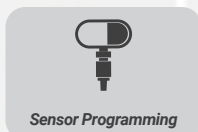

- Touchscreen Interface
- Make, Model, Year lookup via VIN scan
- Activates all OEM sensors, displays all sensor data
- Worldwide vehicle coverage, always up to date
- Ability to reset vehicles via both manual and OBD II relearn
- Programs all leading aftermarket sensor brands
- Provides TPMS relearn procedures on-screen
- Indicates OE sensor and service kit part numbers
- Displays TPMS data for up to 7 tires in one screen
- Supports Placard Adjustment
- Wi-Fi Updating
- DOT Manual Recording
- Read/Clear TPMS DTC Codes
- Tire Tread Depth Functionality (Accessory Sold Separately)

TSAP-3 P/N: 302020529

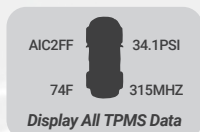

- Display all TPMS sensor data on screen
- Program over 20 aftermarket sensors
- Update wirelessly via Wi-Fi
- Activates both 315 & 433 MHz sensors
- Perform 200 + manual & OBD II relearns
- Service motorcycles & dually vehicles
- Lookup TPMS sensor part numbers
- Test/diagnose vehicle keyfob

	TSAP-3	TSAP-5
TOUCHSCREEN INTERFACE	×	✓
Y/M/M VIN SCAN LOOKUP	×	✓
Wi-Fi UPDATABLE	✓	✓
READ/CLEAR TPMS DTC CODES	×	✓
TIRE TREAD DEPTH FUNCTIONALITY	×	✓
DOT RECORDING	×	✓

Launch Sensors

LAUNCH UNIVERSAL & PROGRAMMABLE TPMS SENSOR



High OptimizedRF Antennd



Cover 99% vehicle TPMS application



Battery life of 4 to 5 years



Unlimited Programming Times



315MHz/433MHz



0.1mm accuracy

PART NUMBER	PACKAGE
301050885	LTR TPMS Sensor 20 Package
301050886	LTR TPMS Sensor 40 Package
301050887	LTR TPMS Sensor 100 Package
301050888	LTR TPMS Sensor 200 Package

FEATURES

- The LTR-V is significantly smaller than its predecessor but offers a stronger signal.
- Optimized RF antenna for better signal transmission.
- Able to replace all the OE tire pressure sensors, copy the OE sensor data and can be programmed for unlimited times.
- Compatible with more than 98% of OE sensors in 315MHz/433MHz.
- Over-the-air wireless programming and battery life lasts for 4 to 5 years.
- The pressure value of LTR Sensor can be accurate to 0.1BAR with an international leading automotive-grade chip.

SPECIFICATIONS



433MHz/315MHz



3.0V



5-8 dBm



-40°F~125°F



27.2*20*76.4(mm)
1.07*0.79*3.01 in

Millennium Series

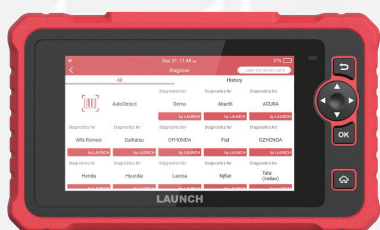

Millennium Max



Millennium Master 2.0



Millennium OBD



Millennium 30 Plus

MILLENNIUM MAX

P/N: 301050679 / 301050707



Adjustable Kickstand

FEATURES

- 7-inch touch screen for smooth operating and data reading.
- Supports 10 OBD II/ EOBD diagnostics.
- Supports 31 advanced special functions.
- Auto Detect VIN to access vehicle info within seconds.
- Updatable software via Wi-Fi.
- One click to generate the diagnostic report and upload.
- Multiple languages supported.

31 SERVICE FUNCTIONS



SPECIFICATIONS

7" touchscreen	9V-18V	Lithium Battery	32GB
3GB	Android™ 10.0	9.89x5.8x1.4 (in)	<1.44lbs

MILLENNIUM MASTER 2.0

P/N: 301050822



FEATURES

- Compatible with 1996 and newer vehicles, light truck, or hybrid manufactured vehicles (OBD II & CAN).
- Read and erase DTCs, view live data of engine system, AT, SRS, and ABS.
- One-click software upgrade via Wi-Fi.
- Functions include Oil Maintenance Reset, Electric Throttle Relearn, Steering Angle Reset.
- Supports OBD II 9 test modes.
- Automatically identify vehicle VINs.
- Upload diagnostic report to the cloud.

13 SERVICE FUNCTIONS



TPMS Reset



DPF Regen



Brake Reset



Injector Coding



Oil Reset



Immobilizer Reset



Engine Power Balance Monitoring



AdBlue Reset



ABS Bleeding



AFS Reset



Battery Reset



SAS Reset



AIR/FUEL Change

SPECIFICATIONS



5" color screen



9V-18V



Standard 16 PINs OBD II



16GB



2GB

MILLENNIUM OBD

P/N: 341051503



FEATURES

- Look up the definition of diagnostic trouble codes(DTCs).
- Graph live data of multiple sensors displayed.
- Features freeze frame data to do fast and accurate repairs.
- Features I/M Readiness function with one click key.
- View vehicle information to check VIN and its condition.

SPECIFICATIONS



2.8" LCD



9V-18V



14°F~122°F



9.18x6.74x1.97 in

MILLENNIUM 30 PLUS

P/N: 307010408



FEATURES

- Compatible with vehicles manufactured in 1996 and newer (OBDII & CAN)
- Supported Protocols: ISO9141-2, ISO14230-4, SAEJ1850, ISO15765-4
- Supports all 10 test modes of OBDII
- Key Functions:
Read and clear diagnostic trouble codes (DTCs),
View live data stream, Retrieve VIN information,
Display freeze frame data, I/M readiness
status check
- Additional Features:
O2 Sensor Test, DTC Lookup Library, Real-Time
Graphing, Battery Voltage Test, Multi-language
support

SPECIFICATIONS



1.7"



9V-16V



32°F-122°F



6.77x2.76x1.89 (in)

EASY-TO-USE INSPECTION EQUIPMENT



BST860S



BST560S



BST360

BST860S

P/N: 307020135





FEATURES

- International measurement standards supported include CCA, BCI, CA, MCA, JIS, DIN, IEC, EN, SAE, GB.
- The reports to be printed anytime by built-in thermal printer or scan QR to view on the mobile phone.
- Available to the batch inspection of battery by testing continuously and repeatedly.
- Applicable battery types, include 12V (Regular Flooded, Gel battery, AGM battery, EFB battery and lithium battery).
- 6 battery & electrical test functions supported include Ripple Detection, Battery Test, Electric Current. Test, Starter Test, Charging System Test and Voltage Test.
- Generate the health report within 3 seconds intuitively display all data on the color screen.
- Applicable vehicles include car, motorcycles, lawnmowers, and other gardening machines, Group 31, commercial vehicles 4D/8D.
- Applicable 12V vehicle's Starter Test and Charging System Test.
- Multi-language supported.

SPECIFICATIONS

 2.4" TFT LCD display with backlight

 25.98 irreplaceable test cable

 -0.4~140°F

 11.12oz

 7.68*3.94*1.58 (in)

BST560S

P/N: 307020133



FEATURES

- International measurement standards supported include CCA, BCI, CA, MCA, JIS, DIN, IEC, EN, SAE, GB.
- Generate the health report within 3 seconds intuitively display all data on the color screen.
- Available to the batch inspection of battery by testing continuously and repeatedly.
- Applicable vehicles include car, motorcycles, lawnmowers, and other gardening machines, Group 31, commercial vehicles 4D/8D.
- Multi-language supported.
- 6 battery & electrical test functions supported include Ripple Detection, Battery Test, Electric Current Test, Starter Test, Charging System Test and Voltage Test.
- Added QR scan function to review the report on the mobile phone.
- Applicable 12V vehicle's Starter Test and Rectifier Diode Test.
- Applicable battery types, include 12V (Regular Flooded, Gel battery, AGM battery, EFB battery and lithium battery).

SPECIFICATIONS



2.4"



25.98 irreplaceable test cable



-0.4~140°F



11.12oz



6.11*3.35*1.26 (in)

BST360

P/N: 301180946

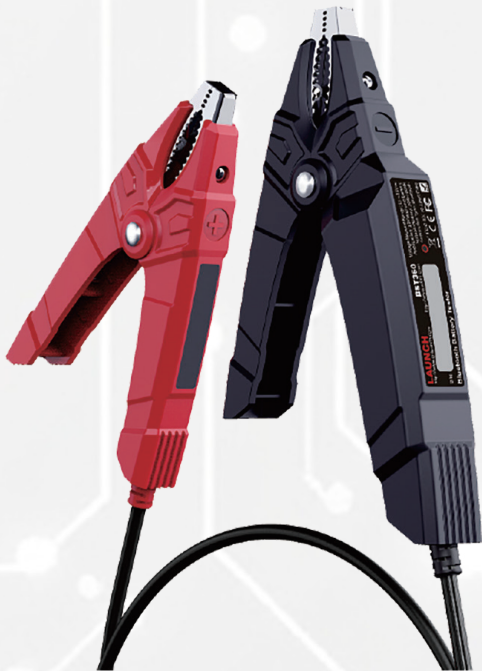

FEATURES

INTERNATIONAL MEASUREMENT STANDARDS:

CCA, JIS, GB, SAE, MCA, CA, DIN, IEC, EN, BCI

3S QUICK DETECT:

Generate the health report within 3 seconds and intuitively display all data on the smart device

DATA TRANSMISSION:

The test data can be exported and downloaded via smartphone and diagnostic tools

SAFETY:

No heating, no discharge, no spark, no operating risks

VARIETY BATTERY & ELECTRICAL TEST FUNCTIONS:

Ripple detection, battery test, starter test, charging system test, electric current and voltage test

BATTERY TYPES:

6V and 12V (Lead-acid battery, gel battery, and AGM battery)

BATTERY TESTER COMPARISON CHART



BST860S



BST560S



BST360

SPECIFICATIONS			
Operating System			
Display Screen	2.4" TFT LCD with Backlight		
RAM			
Storage			
Work Temperature	0~140°F, -18~-60°C		

FEATURES			
Battery Type	Lead-acid, Gel, AGM, EFB, Lithium		Lead-acid, Gel, AGM
Battery Standard	CCA, BCI, CA, MCA, JIS, DIN, IEG, EN, SAE, GB		
Battery Voltage Range	12V		
Work Mode	Standalone		with X-431 Diagnostic Tool or Mobile
System Supported			
Reset Functions			
Auto VIN			
Full OBD II Functionalities			
I/M Quick Scan			
Ripple Detection	•	•	•
DTC Lookup & Definition	•	•	•
Battery Test	•	•	•
Electric Current Test	•	•	•
Starter Test	•	•	•
Charging System Test	•	•	•
Voltage Test	•	•	•
3-second Health Report	•	•	•
Share Report	•	•	•
Print	• (Built-in)	•	•
Multilingual	•	•	
Lifetime FREE Software Update			

SHOP EQUIPMENT



VSP-828 Plus



X-881 Pro



X-613 Advanced Wheel Aligner



VSP-600



Tread Master 2.0



TIT-202 Pro



X-605 Plus



PFP-150

Tread Master 2.0

TIRE TREAD DEPTH GAUGE

P/N: 702030019



FEATURES

- 0.1 mm laser measurement accuracy, and reads single tire data in about 3 seconds.
- Two modes: full tread surface or single-groove measurement
- Generates professional reports with tread data, wear analysis, braking distance, and service recommendations.
- License plate recognition with support for multiple regions (U.S., Germany, Italy, Russia, Brazil, etc.)
- Supports single groove depth detection for special patterns of tire.
- Report sharing via QR code or email.

SPECIFICATIONS



Accuracy
0.1 mm



Laser Width
7.09 inches (180 mm)



Charging Port
Type C



Display
3.97 inches, 480*800 pixels



Photo Camera
8 MP



Camera
2 MP, 30 fps



Storage
32 GB



Battery
5000 mAh / 3.7 V

TIT-202 PRO

ADVANCED INFRARED TECHNOLOGY

P/N: 307020098

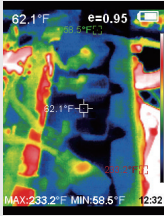
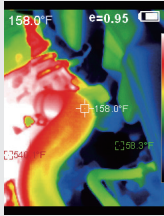
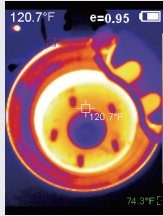
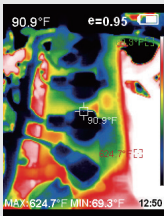
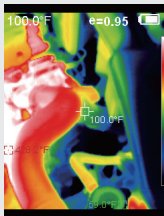
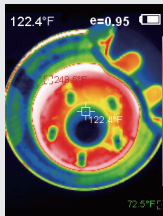
Good			
			

Built-in Database, assist to analyses the problems of vehicle efficiently and effectively. Visually show good or bad status of the vehicle.



FEATURES

- Capture 240 x 320 resolution image to detect the vehicle parts.
- Easily reveal the problem vehicle systems include engine fault, body air tightness, exhaust pipe, brake system, body heating, bearing system, electrical device and more.
- Built-in database comes with hundreds of reference images in the daily diagnosis.
- Record the IR images, up to 20,000.
- Dual image feature.

SPECIFICATIONS



3.5" 240x320



JPG



20,000 pictures



12.35oz



-4°F~1022°F



300,000 pixels



220x160



Micro USB 2.0



Rainbow, iron red, cool color, black & white, white & black



8.81x2.95x4.01 (in)

VSP-828 PLUS

ROTATING BORESCOPE

P/N: 307020142P



FEATURES

- 210° two-way articulation for precise inspection
- 1280*720 HD Resolution.
- 3 brightness levels
- Compatible with iOS/Android smartphones, diagnostic tools (such as X-431), tablets, and PCs
- Heat protection with warning signals
- Lightweight and portable design for workshop or field use

SPECIFICATIONS



Camera Head Diameter
0.22 in (5.5 mm)



Resolution
1280x720



Bending Degree
210°



Camera Tube Length
37.8 in (960 mm)



Optimal Focal Distance
1.18-3.94 in (30-100 mm)



LEDs
6 pcs, 3-level brightness adjustment



Dimensions
9.84 x 2.00 x 1.77 in
250 x 51 x 45 mm



Net Weight
0.39 lb (0.175 kg)



Interface
USB-A to Type-C and USB-A to lightning cables (included)



Compatibility
iOS and Android smartphones, diagnostic PCs, and Launch X-431 tools

VSP-600 USB VIDEOSCOPE

P/N: 307110051



FEATURES

- View, record and save images and videos.
- Easy to adjust the strength of lights (6 levels).
- Thin 5.6 mm diameter of the LEN O.D. that can reach most inner structures of vehicles.
- Take pictures easily with the one-click snapshot button.
- View and save images/videos on Launch X-431 scanner.
- Scan QR code to download the software.

SPECIFICATIONS



LEN O.D.
5.6 mm



TUBE O.D.
4.8 mm



TUBE LENGTH
31.5 in



USB PORT
USB 2.0 Type C/
Micro USB



RESOLUTION
1280*720



Working Temperature
32°F~149°F



POWER SUPPLY
5V

PFP-150

P/N: 307020131



FEATURES

- 6 Protection Modes: Reverse Protection, Short Circuit Protection, Low Voltage Protection, Overheat Protection, Overcharge Protection, Synchronous Rectification.
- Programming Mode: Provide a stable voltage source for the car in need of programming or decoding.
- Exhibit Mode: For continual charge with low current in showrooms.
- Normal Mode: Select the charging mode according to the position of vehicle battery (inside or outside).
- Repair Mode: Indicate whether the battery should be repaired or not. Work with various batteries, such as AGM Battery, GEL Battery, and Lithium Battery.
- Max current up to 150 amp.

APPLICABLE VEHICLES



SPECIFICATIONS



WEIGHT
19.84 lbs



INPUT VOLTAGE
110V



POWER
1800 W



MAX. CURRENT
150 A



CHARGING VOLTAGE
12 V



PROGRAMMING MODE
12-14.8V/2-150A



MAH
10-1800Ah



DIMENSION
17.33*16.15*5.52 (in)



ELECTRIC CABLE LENGTH
9.84 ft/16.40ft

X-605 Plus

INJECTOR CLEANER & TESTER

P/N: 703010115



FEATURES

- Enlarged visual inspection window with background lighting for spray pattern analysis
- Ultrasonic Cleaning: Simultaneous multi-injector cleaning with strong ultrasonic action to remove any carbon deposits and filter residues.
- Fuel Injection Quantity Detection: Measures precise injection amounts under timed conditions
- Sealing & Leakage Test: Verifies injector sealing under system pressure
- Automatic Testing Cycles: Simulates real engine conditions for injector evaluation
- Reverse Flush Function: Removes internal contaminants and residues with reverse flow
- Uniformity & Spray Pattern Test: Evaluates spray atomization and consistency across injectors
- Resistance test feature provides a quick diagnostic of up to 6 injectors resistance simultaneously.

SPECIFICATIONS



VOLTAGE INPUT
AC110V/AC220V
50Hz/60Hz



FUEL TANK CAPACITY
~2.5 L



WORKING PRESSURE
0-6 bar



RESISTANCE TEST RANGE
0-24 K Ω



MACHINE POWER
~250 W



PW
0.1~25.0 ms Step: 0.1 ms



TIMER RANGE
1~9,990 s



SIMULATION SPEED RANGE
1~9,990 rpm (adjustable)



ULTRASONIC CLEANING POWER
~100 W



OPERATING TEMPERATURE
0°C~40°C



RELATIVE HUMIDITY
<85%

X-881 PRO

P/N: 702020089



**WORKS WITH
2 POST LIFTS!**

FEATURES

- True 2-Post, Multi-Bay Aligner capable of compensating for uneven floors up to 30 degrees
- An ideal second aligner for high-volume shops.
- Less than one foot run-out compensation, ensuring precision in alignment.
- Includes an automatic VIN decoder and wireless scanner.
- Comes with an HP printer and dust cover.
- Enables small 2-bay shops with 2-post lifts to perform alignments.
- Black & Gold Target Filtering Technology, utilizing German and Italian-developed optics.
- Provides complete parameter measurements, including SAI, wheelbase setback, and track data.
- 2 years of software updates provided.
- Remote tech support available and Wi-Fi enabled.

SPECIFICATIONS



POWER
AC 110/220 V 50/60 Hz



WHEEL BASE
4000 mm Accuracy: ± 2 mm



Customizable Database
60GB



CASTER
 $\pm 20^\circ$ Accuracy: $\pm 0.03^\circ$



OPERATING SYSTEM
64-bit Windows 10



MEMORY
2GB



MONITOR
32" color monitor



RETRACTION ANGLE
 $\pm 5^\circ$ Accuracy: $\pm 0.03^\circ$



PROCESSOR
Intel Series



RIM DIAMETER
10 - 24 inch



THRUST ANGLE
 $\pm 10^\circ$ Accuracy: $\pm 0.01^\circ$



WHEEL TRACK
2000 mm Accuracy: ± 2 mm

X-613 ADVANCED WHEEL ALIGNER



PART NUMBER	PRODUCT DESCRIPTION
702020112	X-613 Advanced Wheel Aligner
702020112TF	X-613 Advanced Wheel Aligner (with X431 Throttle V Tablet, Full Automotive Software)

FEATURES

- **SUPER SIMPLE AND SPACE SAVING:**
No installation, wiring, calibration, beams, or cabinets required. With a compact footprint, its suitable for various repair shops.
- **COMPACT PACKAGING DESIGN:**
Significantly reduces footprint by utilizing molded case storage and wall mounts.
- **FAST AND ACCURATE RESULTS:**
Delivers high-precision test results quickly. Test reports can be shared via QR code or email.
- **MAGNETIC MEASURING UNIT:**
No assembly or wiring needed - ready to use right out of the box.
- **COMPREHENSIVE DATABASE:**
Offers coverage for a broad range of vehicles across Domestic, European, and Asian markets.

Package 1/3



Package 2/3

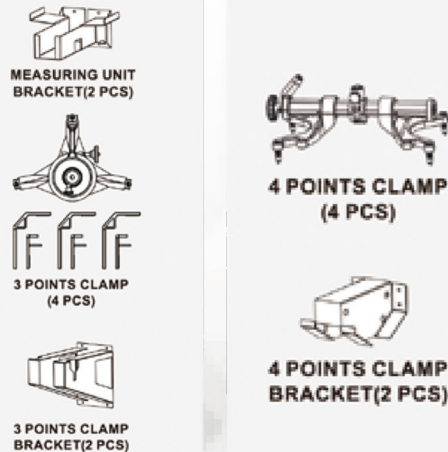

Package 3/3



IMMO PRODUCTS



X-PROG 3



X-PROG 3 PC ADAPTOR

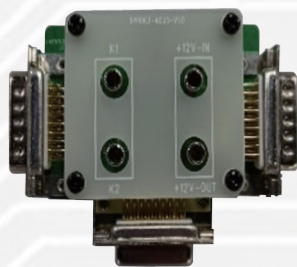

MCU V3 ADAPTOR KITS



**KEY PROGRAMMER
+ KEY* KIT**

IMMO ADD-ON

P/N: 307010302



X-PROG 3

Supports key programming, engine, and gearbox replacement for a variety of vehicles. Retrieve, read, erase, and write ECU information for a range of chips as listed in the product options.

MCU3

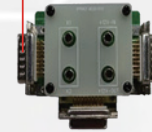

ACTIVATION CARD



Software Subscription



X-PROG 3 PC ADAPTOR

Designed to pair with X-PROG3 for seamless ECU and TCU cloning via your PC. Key features include a 2D menu, a powerful search function, convenient ECU data copy and modification, and fast, stable USB communication.





X-PROG3

P/N: 706020007/301190736

- Vehicle Key Slot To place car key for RF deflection
- DB26 Used to connect to each anti-theft cables
- Key IC hole Used to place the key chip to perform the key matching function
- Status Indicator Power supply indicator lamp
- EEPROM Slot To insert EEPROM board
- Locker To tighten loose EEPROM board
- DC 12V Used to connect to the DC12 power supply
- DB15 To connect with vehicle's DLC
- DIY slot Used to connect the anti-theft ECU pin through the cable to read and write data

 Interface
DB26, DB15

 Input Voltage
DC 12V

 Input Current
500mA

 Working Temperature
0-50°C

 Storage Temperature
-20-70°C

X-PROG3 PC ADAPTOR

P/N: 307110093



- Work with X-PROG 3 as an adaptor.
- The Windows software has only clone function.
- Windows based UI and powerful search function.
- Supports BENCH and BOOT mode Read/Write.
- Fast read/write in Windows (about 3 - 5 times of Android).
- Easier files copy and data comparison in Windows.
- Supports data certification which Android doesn't support.

MCU V3 ADAPTOR KITS

ANTI-THEFT PROGRAMMER ANALOG

P/N: 307140131

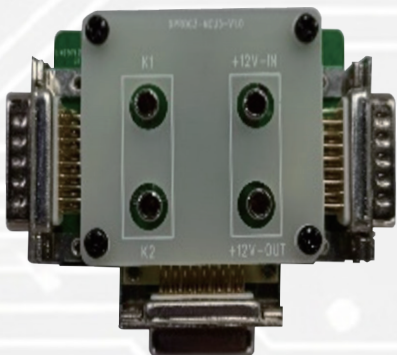

- For the ECU cloning function, you can use the MCU V3 (with built-in resistance and power supply) instead, which is convenient for connection.

X-431 KEY PROGRAMMER

+ KEY*4 KIT P/N: 307110149



Key Programmer

For key chip reading /identification/generation /frequency testing

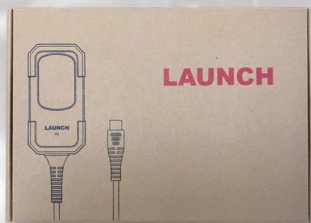

LS4-NISN-01 LN3-PUGOT-01 LK3-VOLWG-02 LE4-FRD-01



Key Programming Cable

TYPEC to USB Connector

UNIVERSAL REMOTE KEYS*4

LS4-NISN-01

USAGE SCENARIO

LS intelligent key is only compatible with vehicle models equipped with the Kessy system; its functions include keyless starting and door edge sensing.

FUNCTION

1. Wireless programming
2. Equipped with anti-theft chip
3. Uses the button cell 2032
4. Circuit board with a 2-year warranty
5. Repeatable writing
6. Batteries need to be installed while generating
7. Supports vehicles with 46,47, MQB48, MQB49, 4A chips

LN3-PUGOT-01

USAGE SCENARIO

Certain chips in LN remote can't generate all vehicle models, it's needed to check whether the type of chip can Supports the vehicle model, the chip is integrated into the remote.

FUNCTION

1. Wireless programming
2. Equipped with anti-theft chip
3. Uses the button cell 2032
4. Circuit board with a 2-year warranty
5. Repeatable writing
6. Batteries need to be installed while generating
7. Supports vehicles with aa, 12,13, 7936,7937, 7947, 7946 chips

LK3-VOLWG-02

USAGE SCENARIO

LK remote is applied in the situations where the remote needs to be matched but the chip is not needed, or it can also be used with super chip.

FUNCTION

1. Wireless programming
2. Not equipped with an anti-theft chip, needs to be used with an anti-theft chip
3. Uses the button cell 2032
4. Circuit board with a 2-year warranty
5. Repeatable writing
6. Batteries cannot be installed while generating

LE4-FRD-01

USAGE SCENARIO

LE remote contains chip and remote, the multimode chip can generate most of the vehicle models and cover the majority of them.

FUNCTION

1. Wireless programming
2. Equipped with a multimode chip
3. Uses the button cell 2032
4. Circuit board with a 2-year warranty
5. Repeatable writing
6. Batteries need to be installed while generating

SUPER CHIP



USAGE SCENARIO

Compatible with chips of most car models for conversion. It can also be matched for vehicle starting.

FUNCTION

Supports 8A, 8C, 8E, 4C, 4D, 4E, 48, 7935, 7936, 7938, 7939, 11/12/13

X-431 MODULES



O2-2 Four Channel Scopebox

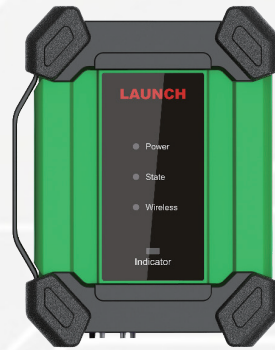

*EM 101N
Two Channel Scopebox*



J560 PLC Trailer Connector



DoIP Cable



Powersport Connectors

02-2 FOUR CHANNEL SCOPEBOX

P/N: 301181101



- ECU Troubleshooting and Diagnostics.
- One Key Enable Function.
- Up to 50M Buffer Memory.
- Self-calibration.
- Automotive Tests (Circuits/Sensors/Actuators/Ignition...).
- X-431 Pro Scanners Compatible.

EM 101N TWO CHANNEL SCOPEBOX

P/N: 301180889



- Works with X-431 diagnostic tool.
- Wireless/Wire connection with X-431 diagnostic tool.
- New UI Design with Three Display Modes.
- Needle Sets, Multimeter Pens, Alligator, Clips and Oscilloscope Channel Test Leads included.
- Automatic measurements include Peak-to-peak value, Average value, Maximum value, Minimum value, Top value, Bottom value, Frequency, Period, etc.

	<i>EM101N DUAL-CHANNEL OSCILLOSCOPE</i>	<i>02-2 FOUR CHANNEL OSCILLOSCOPE</i>
CHANNELS	2	4
BANDWIDTH	10MHz	100MHz
VERTICAL RESOLUTION	8 bits	8 bits
TRIGGER TYPE	Edge, Pulse width	Edge, Pulse width
TRIGGER MODE	Auto, Normal, Single	Auto, Normal, Single SEQ
COMPATIBILITY	X-431 Pro Scanners	X-431 Pro Scanners

02-1/02-2 ACCESSORY KIT

P/N: 203010703

No.	Name	Picture
1	BNC to 4 mm Test Leads	<p>Test lead of a male BNC connector to (2) 4mm connectors. It is a kind of special line for assisting the Oscilloscope to test various types of signals. 4mm connectors are coded in two colors: black (earth wire) and red (positive pole which should be connected with the 6-way Breakout Leads).</p> 
2	6-way Breakout Leads	<p>With these 6-way leads, you will be able to test most of the sensors and actuators on all makes and models of vehicle, including MAP, temperature, throttle position and airflow sensors, fuel pumps, primary ignition circuits and fuel injectors.</p> 
3	USB Cable	<p>Connects the Oscilloscope and diagnostic tool so that the sampled signal can be displayed on the diagnostic tool.</p> 
4	Battery Clamps Cable	<p>To supply power to the Oscilloscope through connection to vehicle's battery.</p> 
5	20:1 Attenuator	<p>It allows the Oscilloscope to measure fuel injector and primary ignition waveforms. *Note: Please note this attenuator should be not used for any high voltage measurements other than fuel injectors</p> 
6	Secondary Ignition Pick-up	<p>This ignition pick-up is applied in the following situations: Secondary-distributor ignition analysis, Secondary-simultaneous ignition analysis and Secondary-direct ignition analysis.</p> 
7	COP (Coil-on-Plug) Extension Cord	<p>Coil-on-Plug extension cord (including earth cord) allows you to take accurate secondary ignition measurements on secondary-direct (Coil-on-Plug) ignition systems. It can be applied in the condition that there are no, or limited access</p> 
8	Multimeter Probes	
9	Crocodile Clips	<p>Designed to connect the bare terminals or leads.</p> 
10	Back Probe Pins Suite	<p>They are mainly used for piercing the insulation of wires to allow for automotive electrical measurements without causing damage to the wires. Additionally they can be used as pin-tip probes while working with small circuit boards.</p> 

COMMERCIAL TRAILER J560 PLC CONNECTOR

P/N: 203010713



- NON-CONDUCTIVE PLASTIC
- WEATHER-RESISTANT
- 7+9 PIN TRAILER CONNECTOR
- WORKS WITH LAUNCH HD SOFTWARE
- Can be powered by the trailer harness or with the included external power pack.

DOIP CABLE

P/N: 203010742



Required for Turbo III to enable advanced diagnostics on certain vehicles using the DoIP protocol.

This cable ensures fast, reliable communication for diagnosing modern vehicles equipped with DoIP-compatible systems.

POWERSPORT CONNECTORS AND SOFTWARE

P/N: 301181175



POWERSPORT DIAGNOSTIC CONNECTOR PACKAGE CONTENTS:

No.	Part	Part Name	Quantity
1	Diagnostic Connector	Honda motorcycle 4PIN diagnostic connector	1
2		Yamaha motorcycle-4+3+3+1+1 diagnostic cable	1
3		Kawasaki motorcycle 4+6PIN diagnostic connector	1
4		Suzuki motorcycle 4+6PIN diagnostic connector	1
5		Harley motorcycle OBD16 to 4PIN diagnostic cable	1
6		Harley motorcycle OBD16 to 6PIN diagnostic cable	1
7		BMW motorcycle 10PIN to OBD 16 diagnostic cable	1
8		Ducati motorcycle 4PIN diagnostic cable	1
9		EURO5 motorcycle 6PIN diagnostic cable	1
10		INDIAN, POLARIS, VICTORY 8 Pin diagnostic cable	1

AVAILABLE ON



X-431 THROTTLE V



X-431 TORQUE LINK



X-431 TURBO III



X-431 TORQUE AUTOHD PRO



Millennium Max

SMARTLINK TOOLS



SMARTLINK B

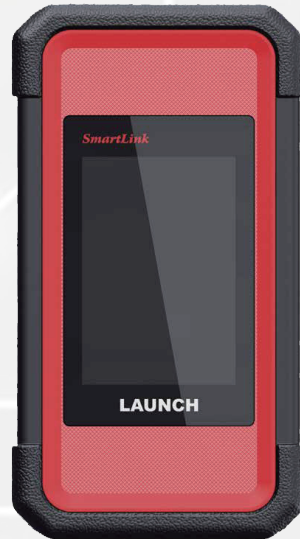

SMARTLINK C

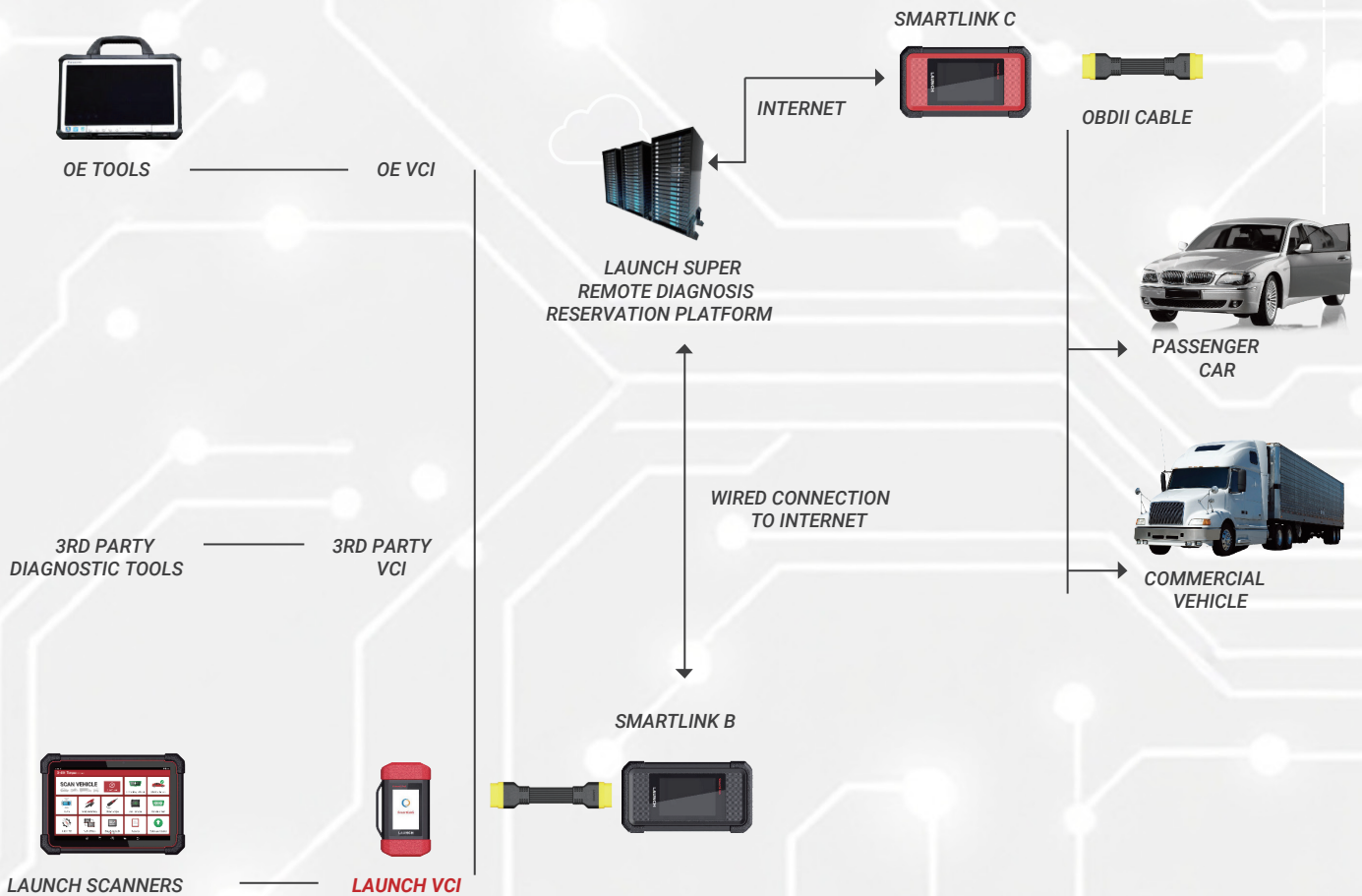

SMARTLINK C HARDWARE

STANDALONE J2534 REFLASHING DEVICE
COMPATIBLE WITH OE SOFTWARE PLATFORMS

P/N: 301181118



FEATURES

- When paired with the Launch Smartlink B, allows for the ability to perform Remote OE Software Reflashes.
- Adheres to new age vehicle network protocols such as DoIP, CANFD, CAN 2.0.
- Publish requests and accept offers from Launch Super Remote Diagnosis Reservation Platform.



DIAGNOSIS



PROGRAMMING



CODING

SMARTLINK B HARDWARE

DIAGNOSING FROM A THOUSAND MILES AWAY

P/N: 321180301

Smartlink B Platform One Year Service (301180823)



- Acts as a pass-thru device for remote diagnostics, programming, and coding using OEM tools.
- Works with Launch X-431 series, OEM tools, and third-party diagnostic platforms.
- Compatible with J2534, DoIP, RP1210, D-PDU, CAN2.0, and CANFD.
- Online platform for publishing and accepting remote service requests.

OUR STORY

Launch Tech USA is a leading supplier of diagnostic tools and solutions for over 14 years in the American market.

Our mission is to provide the most innovative and cost-effective solutions in the automotive aftermarket.

Based on over 800 R&D engineers in Launch headquarters, Launch Tech USA introduces new products into the market every year, keeping up with the new trends of diagnostic industry.



@_launchtechusa



@launchtechusa



@LaunchTechUSA



/launch-tech-usa



@_launchtechusa

Visit our website:

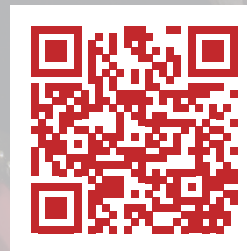

www.launchtechusa.com

Scan the QR code to
view our products online:



LAUNCH

SmartLink

LAUNCH

LAUNCH

LAUNCH
TECH USA
FOCUS & INNOVATE

The final interpretation right of this document belongs to LAUNCH TECH USA, INC.



1-877-528-6249



www.launchtechusa.com



sales@launchtechusa.com

Follow Us

